

TFT LCD MONITOR

USER MANUAL

HME Series

Models

L101HM - L104HM - L121HM

L151HM - L152HM - L156HM

L171HM - L172HM - L191HM

L192HM - L215HM - L240HM

L270HM - L320HM - L420HM

L460HM



Table Of Contents.....	P2
Warning.....	P2
Precautions.....	P3
Safety Precautions.....	P3
About this user manual.....	P4
1_IR remote control.....	P4
2_LCD monitor Mounting Guide.....	P6
3_Monitor controls.....	P8
4_Connections.....	P9
5_Monitor settings via OSD menu.....	P10
6_Special features.....	P12
7_Technical specifications.....	P13
Appendixes.....	P26

Warning:

TO REDUCE THE RISK OF FIRE OR ELECTRIC SHOCK, DO NOT EXPOSE THIS PRODUCT TO RAIN OR MOISTURE.

DO NOT INSERT ANY METALLIC OBJECT THROUGH VENTILATION GRILLS.

Caution:

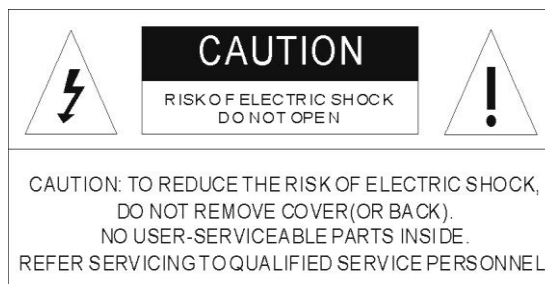

Explanation of Graphical Symbols



Danger: This symbol is intended to alert the user to the presence of un-insulated "dangerous voltage" within the product's enclosure that may be of sufficient magnitude to constitute a risk of electric shock to a person.



Warning: This symbol is intended to alert the user to the presence of important operating and maintenance (servicing) instructions in the literature accompanying the appliance.

Precautions

Safety-----

Should any liquid or solid object fall into the cabinet, unplug the unit and have it checked by the qualified personnel before operating it any further.

Unplug the unit from the wall outlet if it is not going to be used for several days or more. To disconnect the cord, pull it out by the plug. Never pull the cord itself.

Allow adequate air circulation to prevent internal heat built-up. Do not place the unit on surfaces (rugs, blankets, etc.) or near materials (curtains, draperies) that may block the ventilation holes.

Safety Precautions

Federal Communications Commission (FCC) Statement

This Equipment has been tested and found to comply with the limits for a Class B digital device, pursuant to Part 15 of the FCC rules. These limits are designed to provide reasonable protection against harmful interference in a residential installation. This equipment generates, uses and can radiate radio frequency energy and, if not installed and used in accordance with the instructions, may cause harmful interference to radio communications. However, there is no guarantee that interference will not occur in a particular installation.

If this equipment does cause harmful interference to radio or television reception, which can be determined by turning the equipment off and on, the user is encouraged to try to correct the interference by one or more of the following measures:

- Reorient or relocate the receiving antenna.
- Increase the separation between the equipment and receiver.
- Connect the equipment into an outlet on a circuit different from that to which the receiver is connected.
- Consult the dealer or an experienced radio/TV technician for help.

- You are cautioned that changes or modifications not expressly approved by that party responsible for compliance could void your authority to operate the equipment.

This device complies with Part 15 FCC Rules. Operation is subject to the following two conditions:

- (1) This device may not cause harmful interference.
- (2) This device must accept any interference received including interference that may cause undesired

Installation-----

Do not install the unit in an extremely hot or humid place or in a place subject to excessive dust or mechanical vibration.

The unit is not designed to be waterproof. Exposure to rain or water may damage the unit.

Cleaning-----

Clean the unit with a slightly damp soft cloth. Use a mild household detergent. Never use strong solvents such as thinner or benzene as they might damage the finish of the unit.

Retain the original carton and packing materials for safe transport of this unit in the future.

About this user manual

This manual aims at assisting the user on how to operate the monitors described in this manual.

This manual is subject to rigid quality control. However, no guarantee can be given that mistakes are not present. We reserve the right to make changes to the manual without prior notice.

Before operating the appliance, please read this manual carefully and retain it for further reference. Verify that all appliance items are included in the delivery. Should items be missing, do not operate the appliance and contact your local dealer.

Never attempt to repair the appliance yourself. This should only be done by qualified service personnel.

Improper handling of the appliance will invalidate the warranty.

Items included in the delivery

1 x LCD monitor

1 x Power supply unit 12 V DC [Except for the 32"/42"/46"]

1 x Power cord

1 x HDMI cable – optional

1 x IR remote control

1 x User manual

1. IR remote control Instructions:

Power:

Press this button to turn the monitor on/off.

Zoom:

Press this button to toggle between the different picture formats:
Full/16:9/Zoom1/Zoom2



Mute:

Press this button to disable the sound.

Press this button again to turn the sound on again.

PC/HD, AV, SV:

You can select the appropriate signal source directly.

Item:

Hot key for OSD adjustments of Volume, Contrast, Brightness, Colour, Sharpness, Tint and Red Green Blue.

Picture: Hot key for OSD adjustments of picture mode User, Soft, Standard, Vivid.

Source:

To switch the video inputs, please use the IR remote control included in the delivery. This button is also used as "Enter" and "Select" function in the OSD menu. and to confirm your selected settings in the OSD menu.

Menu:

Press this button to call-up the OSD menu.

This button is also used as "Exit".

Note: The menu button is also used to return to the previous menu.

Select ▲/▼:

Directional buttons up/down. Increase or decrease the values in the OSD menu.

Display:

Press this button to call-up screen information such as resolution, signal source, etc.

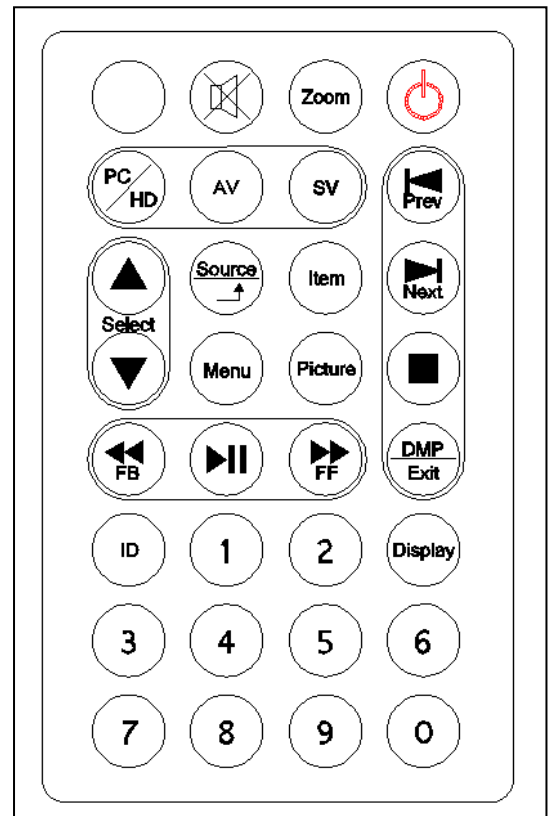



Media player_ Play/Pause.



Media player_ Fast ward to search at a faster speed. (2X, 4X, 8X, 16X, 32X)



Media player_ Fast back to search at a faster speed. (2X, 4X, 8X, 16X, 32X)



Media player_ move to next.



Media player_ move to previous.



Stop Media player.



Enter and Exit Media player. Return to the previous source.

ID: Can be control several monitors are installed in the same area.

In "ID" mode, press ID key, then input setting number (01~99), to unlock "ID" function.

Please press "ID" key again to lock "ID" function.

0~9: For ID setting number used.

USB Media player Instructions:

Press "^{DMP}Exit" button to call-up the OSD menu. Use the ▲ ▼ buttons to select DMP.
then press" Source" to confirm your select.

Use the ▲ ▼ buttons to select Photo/Music/Movie,
and press "Source" button to confirm.

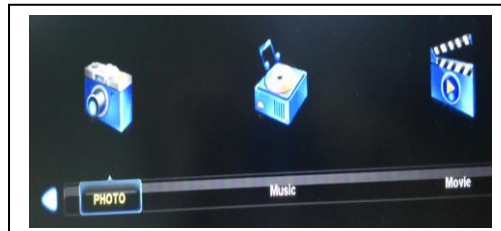

Use the ▲ ▼ buttons to select "C",
and press "Source" button to confirm.

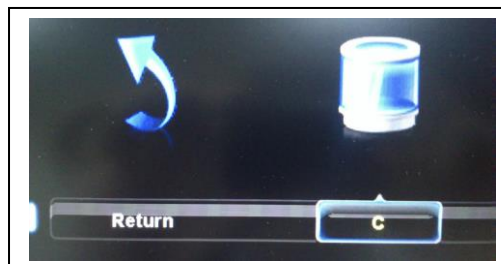

Use the ▲ ▼ buttons to select play file,
and press "Source" button to confirm.

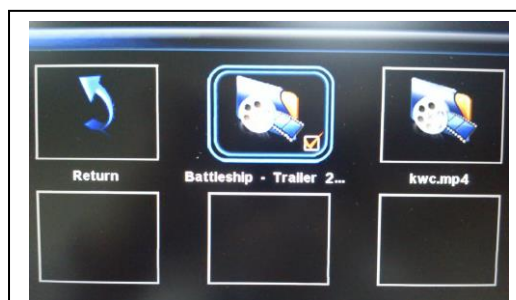

Press **▶||** :to Loading file and play.



Press “Display” button to call-up USB Media Player information.

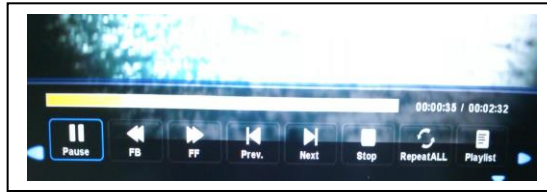

Press ^{DMP} **Exit** : Exit Media player.
Return to the previous source.

2 LCD monitor Mounting Guide

A. Desktop

Adjust the viewing angle of LCD to fit most comfortable monitoring status.

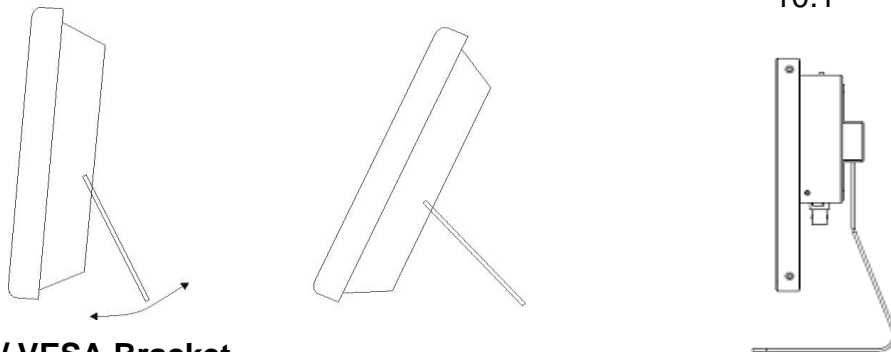

B. Wall mount/ VESA Bracket

Free your space with wall mount design.

Please follow the fix-hole size in back panel to install the LCD to the wall.

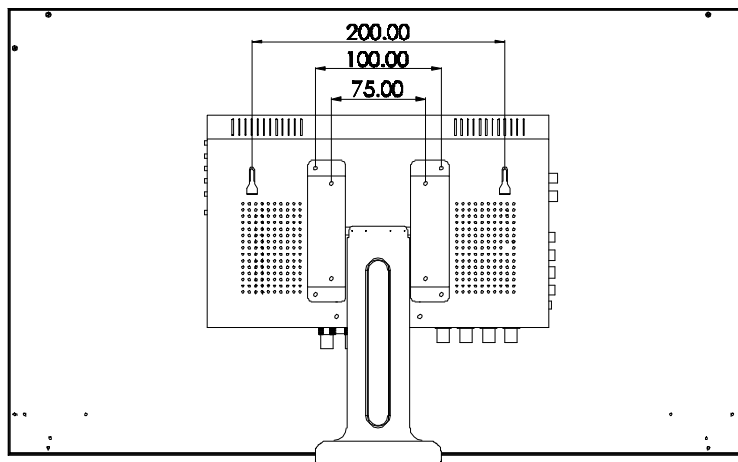

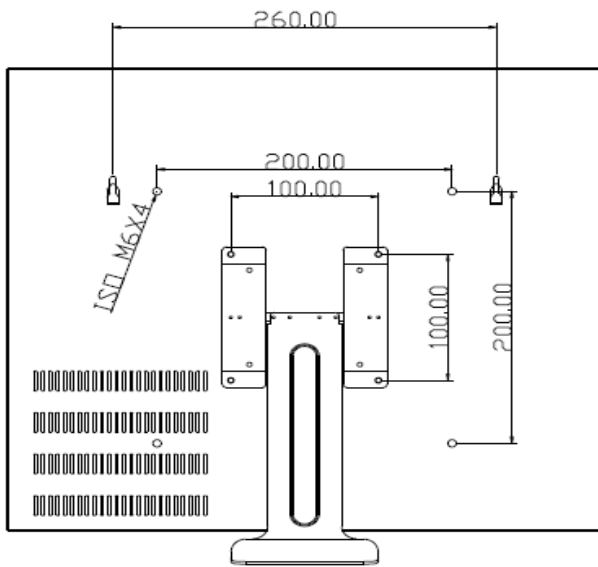

32"

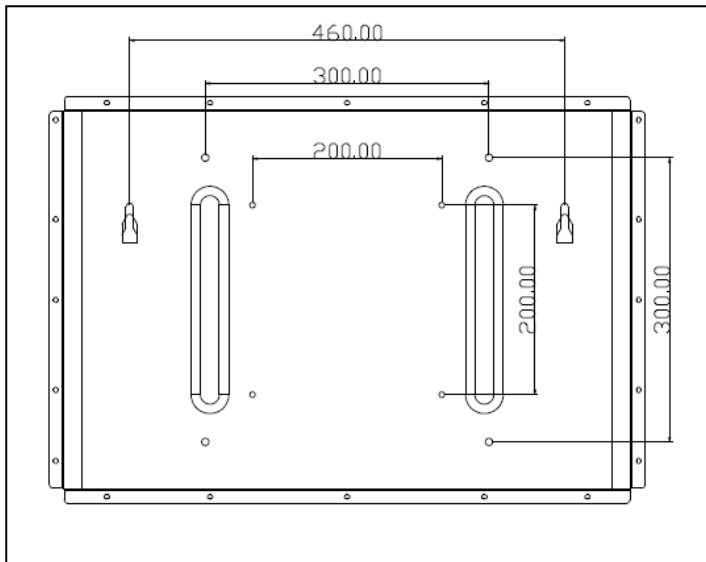

42"/46"

3 Monitor controls

15"/17"/19" Plastic

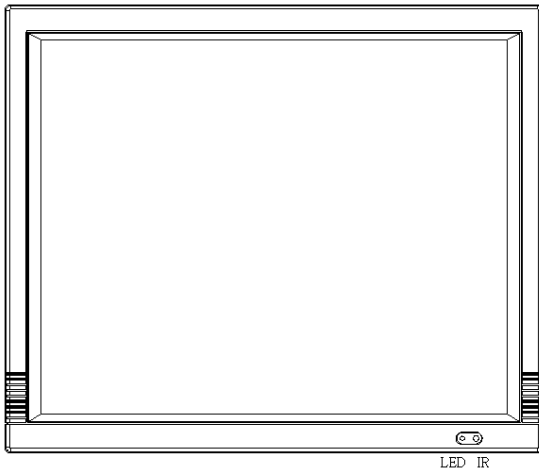

10.4"/12.1"/15"/15.6"/17"/19"/21.5"/24"/27"

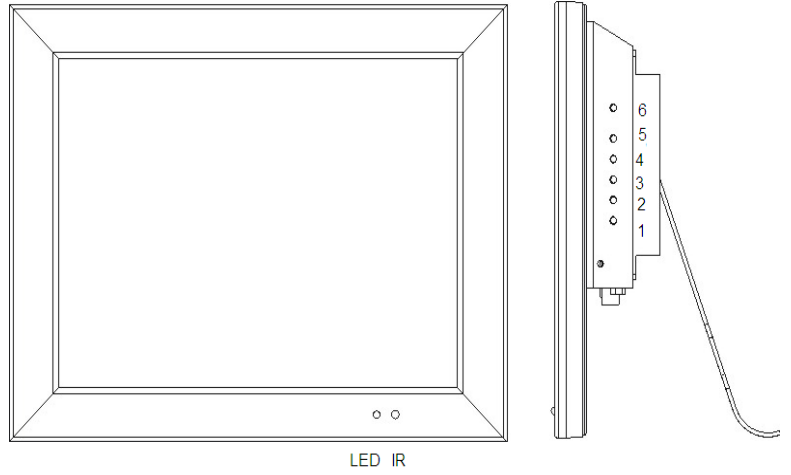

10.1"

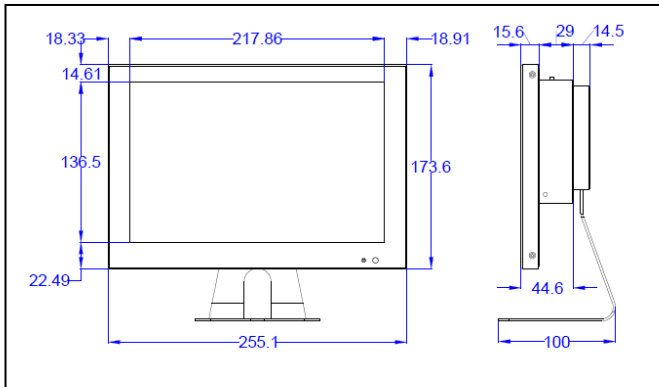

32"/42"/46"

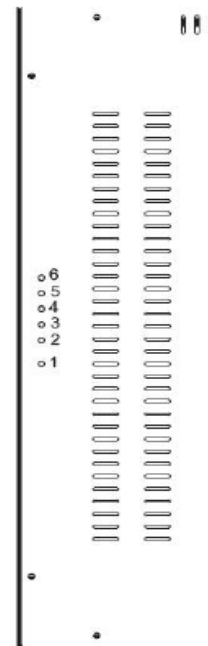
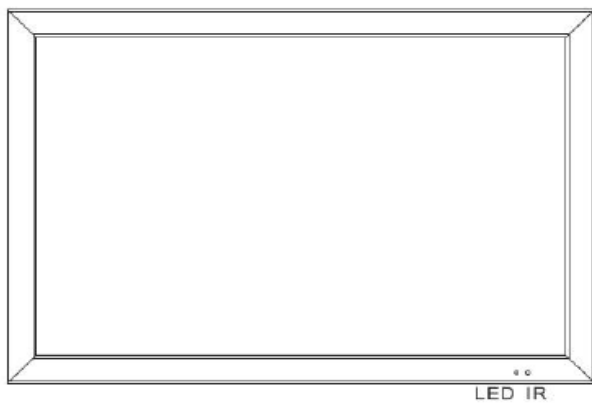

Key pad control Instructions:

(1). Power

Turn the monitor on/off.

LED: Green monitor on. LED: Red standby mode (no input signal)

(2./3). Up / Down ▲/▼

Directional buttons up/down.

Increase or decrease the values in the OSD menu.

(4). Item:

Hot key for OSD adjustments of Volume, Contrast, Brightness, Colour, Sharpness, Tint and Red, Green, Blue.

(5). Menu:

Press this button to call-up the OSD menu.

This button is also used as “Exit”.

(6). Source:

To switch the video inputs.

This button is also used as “Enter and “Select“ function in the OSD menu.

and to confirm your selected settings in the OSD menu.

KEY Lock Function:

Push “Menu” and “Item” , LED flashing, Into key lock mode. OSD show “Key Lock on”

And push again after LED flashing Into key unlock mode. OSD show “Key Lock off”

4. Connections

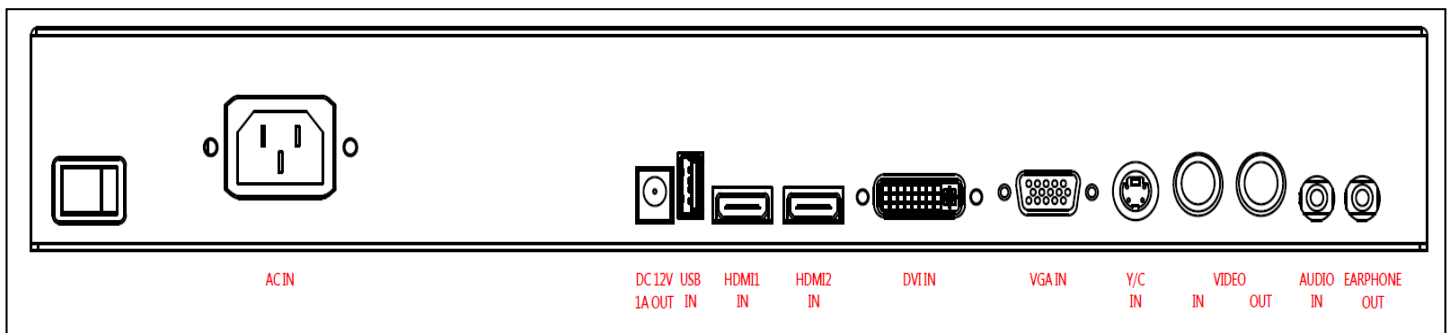
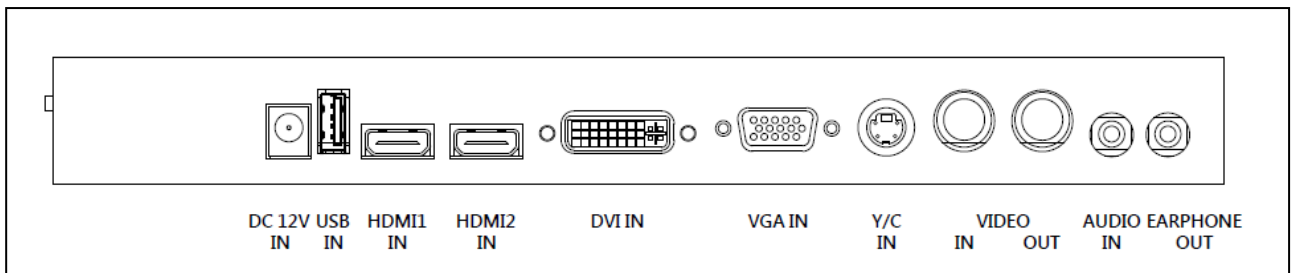

NOTE:

Connections of Audio

	Audio in
AV	√
Y/C	√
VGA	√
DVI	√

5. Monitor settings via OSD menu

Various monitor settings can be made using the OSD menu (On Screen Display).

Press the “Menu” button to call-up the OSD main menu. Here you can make adjustments to the following items:

PICTURE

SOUND

OPTION

SCALER ADJUST

Use the ▲/▼ buttons to toggle between the different items.

Press the Source button to select the appropriate item.

PICTURE

Press source button to confirm. Use the ▲▼ buttons to select adjusts item.

Press the menu button to return to the previous menu item.

Item	Description
Picture Mode	Use the ▲▼ buttons to select the picture mode: User, Vivid, Standard, Soft. In User mode press source button into the function.
Contrast	Use the ▲▼ buttons to increase/decrease the screen contrast.
Brightness	Use the ▲▼ buttons to increase/decrease the screen brightness.
Colour	Use the ▲▼ buttons to increase/decrease the colour.
Sharpness	Use the ▲▼ buttons to increase/decrease the sharpness.
Tint	Use the ▲▼ buttons to increase/decrease the tint.
Colour Temp.	Use the ▲▼ buttons to select the colour temperature: User, Warm, Medium, Cool. In User mode press source button into the function.
Gamma Adjust	Use source button to select the value: Off/1.8/2.0/2.2/2.4
VGA	Use source button to select the screen for PC-VGA. press source button into the function.
Auto adjust	Adjust the best image.
Horizontal Pos	Use the ▲▼ buttons to move the screen image left or right.
Vertical Pos	Use the ▲▼ buttons to move the screen image up and down.
Clock	Use the ▲▼ buttons to adjust image distortion appearing as vertical or “noise” on the screen.
Phase	Use the ▲▼ buttons to adjust image distortion appearing as horizontal or “noise” on the screen.
Noise Reduction	Use the source buttons to select the level of noise reduction: Off, Low, Medium, High, Default.

SOUND

Press source button to confirm. Use the ▲▼ buttons to select adjusts item.

Press the menu button to return to the previous menu item.

Item	Description
Sound Mode	Use the ▲▼ buttons to select the sound mode: User, Standard, Music, Movie, Sport. In User mode press source button into the function.
Treble	Use the ▲▼ buttons to adjust the treble.
Bass	Use the ▲▼ buttons to adjust the bass.
Volume	Use the ▲▼ buttons to adjust the volume.
Mute	Use the source buttons to change the Mute on/off.
Balance	Use the ▲▼ buttons to adjust the balance.

OPTION

Press source button to confirm. Use the ▲▼ buttons to select adjusts item.

Press the menu button to return to the previous menu item.

Item	Description
OSD Language	Press source button into the function. Use the ▲▼ buttons to select the language.
Default	Press source button into the function. Press the “▼” button to restore the factory settings.
SW Update(USB)	Insert USB then press source button into the function.
OSD Time	Use the ▲▼ buttons to setting the OSD menu display time.
Set ID	Can be control several monitors are installed in the same area. Use the source buttons to into the function. then use up/down key to select you setting the number (01~99), then press menu to exit osd. Press IR remote control “ID” key again to confirm the Set ID function.
Screen Saver	Use source button to select the on/off: [Screen protector - Anti blur]
OSD H-Pos	Use the ▲▼ buttons to position the OSD horizontally.
OSD V-Pos	Use the ▲▼ buttons to position the OSD vertically.

SCALER ADJUST

Press source button to confirm. Use the ▲▼ buttons to select item.

Press the menu button to return to the previous menu item.

Item	Description
Scale	Use source button to select the screen Aspect Ratio: Full/4:3/Zoom1/Zoom2
H Zoom	Use the ▲▼ buttons to position the picture horizontally.
V Zoom	Use the ▲▼ buttons to position the picture vertically.

PC timing:

Mode	Resolution
1	800 x 600 @ 60
2	800 x 600 @ 72
3	800 x 600 @ 75
4	1024 x 768 @ 60
5	1280 x 1024 @ 60
6	1360 x 768 @ 60
7	1920 x 1080 @ 60

6. Special features

- Special Video Processor.
- Screen protector (Anti-blur /Image auto move).
- NTSC/PAL Auto Switch.
- 3D De-interlace Technology.
- 3D Comb Filter Technology.
- Luminance transient improvement, Chrominance transient improvement
- Video out support auto termination (75 Ohms).
- Build-in 2W (7W for 42"/46") speaker.
- Support IR remote controller.
- VESA standard bracket 75/100mm.
100/200mm for 32", 200/300mm 42",46".

7. Technical specifications

Monitor model	L101HM
System	PAL / NTSC
LCD panel	10.1"
Active area (mm)	216.96 x 135.6
Picture format	16:10
Max. resolution	1280 x 800
Pixel pitch (mm)	0.1695 x 0.1695
Colours	16.2M
Brightness	350 cd/m ² [LED]
Contrast	800:1
Response time (Tr/Tf)	10/15ms
View angle (U/D/L/R)	85/85/85/85
Video input/output	1 x / 1 x Composite (BNCx2)
USB input	1x A Type (Update F/W, Player MP3, JPEG, MP4)
S-Video input	1 x 4 Pin Mini Dim
HDMI input	2 x HDMI (A Type)
PC input	1 x VGA input (D-Sub 15 pin) 1 x DVI-D input
Audio input	1 x (Phone jack 3.5ψ)
Earphone output	1 x (Phone jack 3.5ψ)
Speaker	2 x speaker (2 watt)
3D Comb Filter	Yes
3D De-Interlace function	Yes
OSD setting	Yes
Power input	AC 100-240V 50/60Hz, Adapter DC 12V/2A
Power consumption	Approx. 10.5 watts
Dimensions (WxHxD) mm	255.1 x 173.6 x 100 (stand)
Weight	1.8 kg
Operating temperature	0° to 50° C

Subject to technical changes without prior notice. Error excepted.

Monitor model	L104HM
System	PAL / NTSC
LCD panel	10.4"
Active area (mm)	210.43 x 157.82
Picture format	4:3
Max. resolution	1024 x 768
Pixel pitch (mm)	0.2054 x 0.2054
Colours	16.7M
Brightness	350 cd/m ² [LED]
Contrast	1000:1
Response time (Tr+Tf)	25ms
View angle (U/D/L/R)	80/80/80/80
Video input/output	1 x / 1 x Composite (BNCx2)
USB input	1 x A Type (Update F/W, Player MP3, JPEG, MP4)
S-Video input	1 x 4 Pin Mini Dim
HDMI input	2 x HDMI (A Type)
PC input	1 x VGA input (D-Sub 15 pin) 1 x DVI-D input
Audio input	1 x (Phone jack 3.5ψ)
Earphone output	1 x (Phone jack 3.5ψ)
Speaker	2 x speaker (2 watt)
3D Comb Filter	Yes
3D De-Interlace function	Yes
OSD setting	Yes
Power input	AC 100-240V 50/60Hz, Adapter DC 12V/5A
Power consumption	Approx. 11 watts
Dimensions (WxHxD) mm	266.2 x 213.3 x 74.4
Weight	2.4 kg
Operating temperature	0° to 50° C

Subject to technical changes without prior notice. Error excepted.

Monitor model	L121HM
System	PAL / NTSC
LCD panel	12.1"
Active area (mm)	245.76 x 184.32
Picture format	4:3
Max. resolution	1024 x 768
Pixel pitch (mm)	0.240 x 0.240
Colours	16.7M
Brightness	500cd/m ² [LED]
Contrast	1000:1
Response time (Tr/Tf)	13/12ms
View angle (U/D/L/R)	89/89/89/89
Video input/output	1 x / 1 x Composite (BNCx2)
USB input	1 x A Type (Update F/W, Player MP3, JPEG, MP4)
S-Video input	1 x 4 Pin Mini Dim
HDMI input	2 x HDMI (A Type)
PC input	1 x VGA input (D-Sub 15 pin) 1 x DVI-D input
Audio input	1 x (Phone jack 3.5ψ)
Earphone output	1 x (Phone jack 3.5ψ)
Speaker	2 x speaker (2 watt)
3D Comb Filter	Yes
3D De-Interlace function	Yes
OSD setting	Yes
Power input	AC 100-240V 50/60Hz, Adapter DC 12V/5A
Power consumption	Approx.17 watts
Dimensions (WxHxD) mm	300 x 239 x 61
Weight	2.6kg
Operating temperature	0° to 50° C

Subject to technical changes without prior notice. Error excepted.

Monitor model	L151HM & L152HM
System	PAL / NTSC
LCD panel	15.0"
Active area (mm)	304.1 x 228.1
Picture format	4:3
Max. resolution	1024 x 768
Pixel pitch (mm)	0.297 x 0.297
Colours	16.2M
Brightness	300 cd/m ² [LED]
Contrast	2000:1
Response time (Tr/Tf)	16/7ms
View angle (U/D/L/R)	88/88/88/88
Video input/output	1 x / 1 x Composite (BNCx2)
USB input	1 x A Type (Update F/W, Player MP3, JPEG, MP4)
S-Video input	1 x 4 Pin Mini Dim
HDMI input	2 x HDMI (A Type)
PC input	1 x VGA input (D-Sub 15 pin) 1 x DVI-D input
Audio input	1 x (Phone jack 3.5ψ)
Earphone output	1 x (Phone jack 3.5ψ)
Speaker	2 x speaker (2 watt)
3D Comb Filter	Yes
3D De-Interlace function	Yes
OSD setting	Yes
Power input	AC 100-240V 50/60Hz, Adapter DC 12V/5A
Power consumption	Approx. 21 watts
Dimensions (WxHxD) mm	357 x 283 x 64
Weight	3.2kg
Operating temperature	0° to 50° C

Subject to technical changes without prior notice. Error excepted.

Monitor model	L156HM
System	PAL / NTSC
LCD panel	15.6"
Active area (mm)	344.16 x 193.59
Picture format	16:9
Max. resolution	1920 x 1080
Pixel pitch (mm)	0.17925 x 0.17925
Colours	16.2M
Brightness	450 cd/m ² [LED]
Contrast	800:1
Response time (Tr/Tf)	13/12ms
View angle (U/D/L/R)	85/85/85/85
Video input/output	1 x / 1 x Composite (BNCx2)
USB input	1 x A Type (Update F/W, Player MP3, JPEG, MP4)
S-Video input	1 x 4 Pin Mini Dim
HDMI input	2 x HDMI (A Type)
PC input	1 x VGA input (D-Sub 15 pin) 1 x DVI-D input
Audio input	1 x (Phone jack 3.5ψ)
Earphone output	1 x (Phone jack 3.5ψ)
Speaker	2 x speaker (2 watt)
3D Comb Filter	Yes
3D De-Interlace function	Yes
OSD setting	Yes
Power input	AC 100-240V 50/60Hz, Adapter DC 12V/5A
Power consumption	Approx. 21 watts
Dimensions (WxHxD) mm	376.61 x 232.7 x 64
Weight	3.5 kg
Operating temperature	0° to 50° C

Subject to technical changes without prior notice. Error excepted.

Monitor model	L171HM & L172HM
System	PAL / NTSC
LCD panel	17.0"
Active area (mm)	337.92 x 270.34
Picture format	5:4
Max. resolution	1280 x 1024
Pixel pitch (mm)	0.264 x 0.264
Colours	16.7M
Brightness	250 cd/m ² [LED]
Contrast	1000:1
Response time (Tr/Tf)	3.8/1.2ms
View angle (U/D/L/R)	80/80/85/85
Video input/output	1 x / 1 x Composite (BNCx2)
USB input	1 x A Type (Update F/W, Player MP3, JPEG, MP4)
S-Video input	1 x 4 Pin Mini Dim
HDMI input	2 x HDMI (A Type)
PC input	1 x VGA input (D-Sub 15 pin) 1 x DVI-D input
Audio input	1 x (Phone jack 3.5ψ)
Earphone output	1 x (Phone jack 3.5ψ)
Speaker	2 x speaker (2 watt)
3D Comb Filter	Yes
3D De-Interlace function	Yes
OSD setting	Yes
Power input	AC 100-240V 50/60Hz, Adapter DC 12V/5A
Power consumption	Approx. 19 watts
Dimensions (WxHxD) mm	391.14 x 325.54 x 69
Weight	3.9kg
Operating temperature	0° to 50° C

Subject to technical changes without prior notice. Error excepted.

Monitor model	L191HM & L192HM
System	PAL / NTSC
LCD panel	19.0"
Active area (mm)	376.32 x 301.056
Picture format	5:4
Max. resolution	1280 x 1024
Pixel pitch (mm)	0.294 x 0.294
Colours	16.7M
Brightness	250 cd/m ² [LED]
Contrast	1000:1
Response time (Tr/Tf)	3.6/1.4ms
View angle (U/D/L/R)	80/80/85/85
Video input/output	1 x / 1 x Composite (BNCx2)
USB input	1 x A Type (Update F/W, Player MP3, JPEG, MP4)
S-Video input	1 x 4 Pin Mini Dim
HDMI input	2 x HDMI (A Type)
PC input	1 x VGA input (D-Sub 15 pin) 1 x DVI-D input
Audio input	1 x (Phone jack 3.5ψ)
Earphone output	1 x (Phone jack 3.5ψ)
Speaker	2 x speaker (2 watt)
3D Comb Filter	Yes
3D De-Interlace function	Yes
OSD setting	Yes
Power input	AC 100-240V 50/60Hz, Adapter DC 12V/5A
Power consumption	Approx. 24 watts
Dimensions (WxHxD) mm	429.86 x 356.6 x 66.7
Weight	5.5kg
Operating temperature	0° to 50° C

Subject to technical changes without prior notice. Error excepted.

Monitor model	L215HM
System	PAL / NTSC
LCD panel	21.5"
Active area (mm)	476.064 x 267.786
Picture format	16:9
Max. resolution	1920 x 1080
Pixel pitch (mm)	0.24795 x 0.24795
Colours	16.7M
Brightness	250 cd/m ² [LED]
Contrast	1000:1
Response time (Tr/Tf)	12/10ms
View angle (U/D/L/R)	89/89/89/89
Video input/output	1 x / 1 x Composite (BNCx2)
USB input	1 x A Type (Update F/W, Player MP3, JPEG, MP4)
S-Video input	1 x 4 Pin Mini Dim
HDMI input	2 x HDMI (A Type)
PC input	1 x VGA input (D-Sub 15 pin) 1 x DVI-D input
Audio input	1 x (Phone jack 3.5ψ)
Earphone output	1 x (Phone jack 3.5ψ)
Speaker	2 x speaker (2 watt)
3D Comb Filter	Yes
3D De-Interlace function	Yes
OSD setting	Yes
Power input	AC 100-240V 50/60Hz, Adapter DC 12V/5A
Power consumption	Approx.22 watts
Dimensions (WxHxD) mm	531.24 x 322.72 x 60.95
Weight	5.7 kg
Operating temperature	0° to 50° C

Subject to technical changes without prior notice. Error excepted

Monitor model	L240HM
System	PAL / NTSC
LCD panel	23.8"
Active area (mm)	527.04 x 296.46
Picture format	16:9
Max. resolution	1920 x 1080
Pixel pitch (mm)	0.24825 x 0.24825
Colours	16.7M
Brightness	250 cd/m ² [LED]
Contrast	3000:1
Response time (Tr/Tf)	10/6ms
View angle (U/D/L/R)	89/89/89/89
Video input/output	1 x / 1 x Composite (BNCx2)
USB input	1 x A Type (Update F/W, Player MP3, JPEG, MP4)
S-Video input	1 x 4 Pin Mini Dim
HDMI input	2 x HDMI (A Type)
PC input	1 x VGA input (D-Sub 15 pin) 1 x DVI-D input
Audio input	1 x (Phone jack 3.5ψ)
Earphone output	1 x (Phone jack 3.5ψ)
Speaker	2 x speaker (2 watt)
3D Comb Filter	Yes
3D De-Interlace function	Yes
OSD setting	Yes
Power input	AC 100-240V 50/60Hz, Adapter DC 12V/5A
Power consumption	Approx.22 watts
Dimensions (WxHxD) mm	585.56 x 353.09 x 63.5
Weight	5.7 kg
Operating temperature	0° to 50° C

Subject to technical changes without prior notice. Error excepted.

Monitor model	L270HM
System	PAL / NTSC
LCD panel	27.0"
Active area (mm)	597.6 x 336.15
Picture format	16:9
Max. resolution	1920 x 1080
Pixel pitch (mm)	0.31125 x 0.31125
Colours	16.7M
Brightness	300 cd/m ² [LED]
Contrast	3000:1
Response time (Tr/Tf)	7/5ms
View angle (U/D/L/R)	89/89/89/89
Video input/output	1 x / 1 x Composite (BNCx2)
USB input	1 x A Type (Update F/W, Player MP3, JPEG, MP4)
S-Video input	1 x 4 Pin Mini Dim
HDMI input	2 x HDMI (A Type)
PC input	1 x VGA input (D-Sub 15 pin) 1 x DVI-D input
Audio input	1 x (Phone jack 3.5ψ)
Earphone output	1 x (Phone jack 3.5ψ)
Speaker	2 x speaker (2 watt)
3D Comb Filter	Yes
3D De-Interlace function	Yes
OSD setting	Yes
Power input	AC 100-240V 50/60Hz, Adapter DC 12V/5A
Power consumption	Approx.28 watts
Dimensions (WxHxD) mm	658 x 396.6 x 67
Weight	7 kg
Operating temperature	0° to 50° C

Subject to technical changes without prior notice. Error excepted.

Monitor model	L320HM
System	PAL / NTSC
LCD panel	31.5"
Active area (mm)	698.4 x 392.85
Picture format	16:9
Max. resolution	1920 x 1080
Pixel pitch (mm)	0.3637 x 0.3637
Colours	16.7M
Brightness	400 cd/m ² [LED]
Contrast	4000:1
Response time (G to G)	6.5ms
View angle (U/D/L/R)	89/89/89/89
Video input/output	1 x / 1 x Composite (BNCx2)
USB input	1 x A Type (Update F/W, Player MP3, JPEG, MP4)
S-Video input	1 x 4 Pin Mini Dim
HDMI input	2 x HDMI (A Type)
PC input	1 x VGA input (D-Sub 15 pin) 1 x DVI-D input
Audio input	1 x (Phone jack 3.5ψ)
Earphone output	1 x (Phone jack 3.5ψ)
Speaker	2 x speaker (7 watt)
3D Comb Filter	Yes
3D De-Interlace function	Yes
OSD setting	Yes
Power input	AC 100-240V 50/60Hz
Power consumption	Approx. 57 watts
Dimensions (WxHxD) mm	761.6 x 455.2 x 75
Weight	13kg
Operating temperature	0° to 50° C

Subject to technical changes without prior notice. Error excepted.

Monitor model	L420HM
System	PAL / NTSC
LCD panel	42.0"
Active area (mm)	930.24 x 523.26
Picture format	16:9
Max. resolution	1920 x 1080
Pixel pitch (mm)	0.4845 x 0.4845
Colours	16.7M
Brightness	400 cd/m ² [LED]
Contrast	3000:1
Response time (G to G)	6.5ms
View angle (U/D/L/R)	89/89/89/89
Video input/output	1 x / 1 x Composite (BNCx2)
USB input	1 x A Type (Update F/W, Player MP3, JPEG, MP4)
S-Video input	1 x 4 Pin Mini Dim
HDMI input	2 x HDMI (A Type)
PC input	1 x VGA input (D-Sub 15 pin) 1 x DVI-D input
Audio input	1 x (Phone jack 3.5ψ)
Earphone output	1 x (Phone jack 3.5ψ)
Speaker	2 x speaker (7 watt)
3D Comb Filter	Yes
3D De-Interlace function	Yes
OSD setting	Yes
Power input	AC 100-240V 50/60Hz
Power consumption	Approx. 83 watts
Dimensions (WxHxD) mm	994.6 x 587.2 x 82.7
Weight	23kg
Operating temperature	0° to 50° C

Subject to technical changes without prior notice. Error excepted.

Monitor model	L460HM
System	PAL / NTSC
LCD panel	46.0"
Active area (mm)	1018.08 x 572.67
Picture format	16:9
Max. resolution	1920 x 1080
Pixel pitch (mm)	0.53025 x 0.53025
Colours	16.7M
Brightness	500 cd/m ² [LED]
Contrast	4000:1
Response time (G to G)	6.5ms
View angle (U/D/L/R)	89/89/89/89
Video input/output	1 x / 1 x Composite (BNCx2)
USB input	1 x A Type (Update F/W, Player MP3, JPEG, MP4)
S-Video input	1 x 4 Pin Mini Dim
HDMI input	2 x HDMI (A Type)
PC input	1 x VGA input (D-Sub 15 pin) 1 x DVI-D input
Audio input	1 x (Phone jack 3.5ψ)
Earphone output	1 x (Phone jack 3.5ψ)
Speaker	2 x speaker (7 watt)
3D Comb Filter	Yes
3D De-Interlace function	Yes
OSD setting	Yes
Power input	AC 100-240V 50/60Hz
Power consumption	Approx.104 watts
Dimensions (WxHxD) mm	1081.5 x 635.45 x 80.5
Weight	25kg
Operating temperature	0° to 50° C

Subject to technical changes without prior notice. Error excepted.

Appendixes

Troubleshooting

The tables provided below include some problems that the user may encounter while using the display and the corresponding solutions. Please refer to the contents of this section prior to contacting service personnel.

Problem	Possible Causes	Solutions
No picture	<ol style="list-style-type: none">1. Is the power cable connected to the unit?2. Is the unit turned on?3. Is the signal cable connected to the unit?4. Is the unit in power saving mode?	<ol style="list-style-type: none">1. Make sure the power cable has been properly connected to the unit.2. Turn on the unit.3. Make sure the signal cable has been properly connected to the unit.4. Press any key on computer keyboard.
Strange colour	<ol style="list-style-type: none">1. Is the signal cable connected to the unit?	<ol style="list-style-type: none">1. Make sure the signal cable has been properly connected to the unit.
Picture distortion	<ol style="list-style-type: none">1. Is the signal cable connected to the unit?2. Is the video input signal within the unit's specified frequency range?	<ol style="list-style-type: none">1. Make sure the signal cable has been properly connected to the unit.2. Make sure the input signal is within the unit's specified frequency range.
Picture is too dim	<ol style="list-style-type: none">1. Have the unit's brightness and contrast settings been set to the lowest level?	<ol style="list-style-type: none">1. Adjust brightness and contrast
Only sound but no picture	<ol style="list-style-type: none">1. Is the connection of the input signal correct?	<ol style="list-style-type: none">1. Check connection of input signal.2. Make sure the signal cable has been properly connected.
Only picture but no sound	<ol style="list-style-type: none">1. Is the signal cable connected to the unit?2. Has the volume been set to the min level?3. Is the audio cable connected to the unit?	<ol style="list-style-type: none">1. Make sure the signal cable has been properly connected to the unit.2. Adjust the volume to an appropriate setting.3. Make sure the audio cable has been properly connected to the unit.

Please contact the customer service centre of your local dealer if you have any questions regarding the unit after reading the information provided above.