

TFT LCD MONITOR

USER MANUAL

8" TFT LCD MONITOR



CE

WARNING:

TO REDUCE THE RISK OF FIRE OR ELECTRIC SHOCK, DO NOT EXPOSE THIS PRODUCT TO RAIN OR MOISTURE.

DO NOT INSERT ANY METALLIC OBJECT THROUGH VENTILATION GRILLS.

CAUTION:



Explanation of Graphical Symbols



The lightning flash with arrowhead symbol, within an equilateral triangle, is intended to alert the user to the presence of uninsulated "dangerous voltage" within the product's enclosure that may be of sufficient magnitude to constitute a risk of electric shock to persons.



The exclamation point within an equilateral triangle is intended to alert the user to the presence of important operating and maintenance (servicing) instructions in the literature accompanying the product.

Precautions

Safety-----

Should any liquid or solid object fall into the cabinet, unplug the unit and have it checked by the qualified personnel before operating it any further.

Unplug the unit from the wall outlet if it is not going to be used for several days or more. To disconnect the cord, pull it out by the plug. Never pull the cord itself.

Allow adequate air circulation to prevent internal heat built-up. Do not place the unit on surfaces(rugs, blankets, etc.) or near materials (curtains, draperies) that may block the ventilation holes.

Installation-----

Do not install the unit in an extremely hot or humid place or in a place subject to excessive dust or mechanical vibration.

The unit is not designed to be waterproof. Exposure to rain or water may damage the unit.

Cleaning-----

Clean the unit with a slightly damp soft cloth. Use a mild household detergent. Never use strong solvents such as thinner or benzine as they might damage the finish of the unit.

Retain the original carton and packing materials for safe transport of this unit in the future.

Safety Precautions

Federal Communications Commission (FCC) Statement

This Equipment has been tested and found to comply with the limits for a Class B digital device, pursuant to Part 15 of the FCC rules. These limits are designed to provide reasonable protection against harmful interference in a residential installation. This equipment generates, uses and can radiate radio frequency energy and, if not installed and used in accordance with the instructions, may cause harmful interference to radio communications.

However, there is no guarantee that interference will not occur in a particular installation.

If this equipment does cause harmful interference to radio or television reception, which can be determined by turning the equipment off and on, the user is encouraged to try to correct the interference by one or more of the following measures:

- Reorient or relocate the receiving antenna.
 - Increase the separation between the equipment and receiver.
 - Connect the equipment into an outlet on a circuit different from that to which the receiver is connected.
 - Consult the dealer or an experienced radio/TV technician for help.
- You are cautioned that changes or modifications not expressly approved by that party responsible for compliance could void your authority to operate the equipment.

This device complies with Part 15 FCC Rules. Operation is subject to the following two conditions:

- (1) This device may not cause harmful interference.
- (2) This device must accept any interference received including interference that may cause undesired

Table Of Contents

● Warning.....	1
● Safety Precautions.....	2
● Table Of Contents.....	3
● Features.....	4
● Operating Instruction.....	5
● Connections.....	6
● OSD Architecture.....	7
OSD Function	
OSD Function PC Mode	
● LCD Monitor Mounting guide.....	10
● Connecting Device.....	11
● Specification.....	12
● Appendixes.....	13
● Remote Control.....	14

Features

LCD80AVH

- Display Pixels 800X600
- Compatible with VGA(640X480),SVGA(800X600)
- Video input support NTSC / PAL standard.
- High brightness of 500 cd/m²
- High contrast 400:1.
- View of 135°/140°, vertical and horizontal.
- ACC, AGC and DCGC (Digital Chroma Gain control).
- LCD response time of 30ms(Tr=12ms/Tf=18ms).
- Support IR remote controller.
- Build-in 2W speaker.
- Friendly OSD Function Controls.
- With mirror function.

Operating Instructions-Control

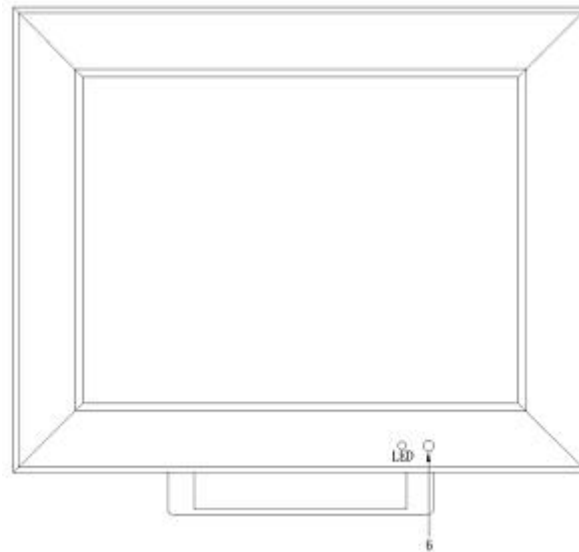

1. Monitor Power ON / OFF.

LED-Green Light -- Power On

LED-Red Light -- --Power Off.

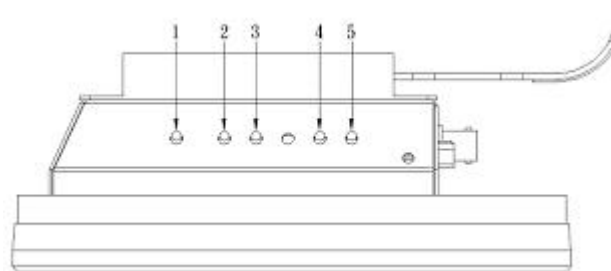

2.3 Adjust UP/DOWN

Increase or decrease the value on OSD menu.

UP: Increase value on the OSD Menu.

Down: Decrease value on the OSD Menu.

4. Menu

OSD menu ON / OFF control.

5. Source

Select signal from AV1, AV2, VGA.

6. IR

For Remote control

Connections

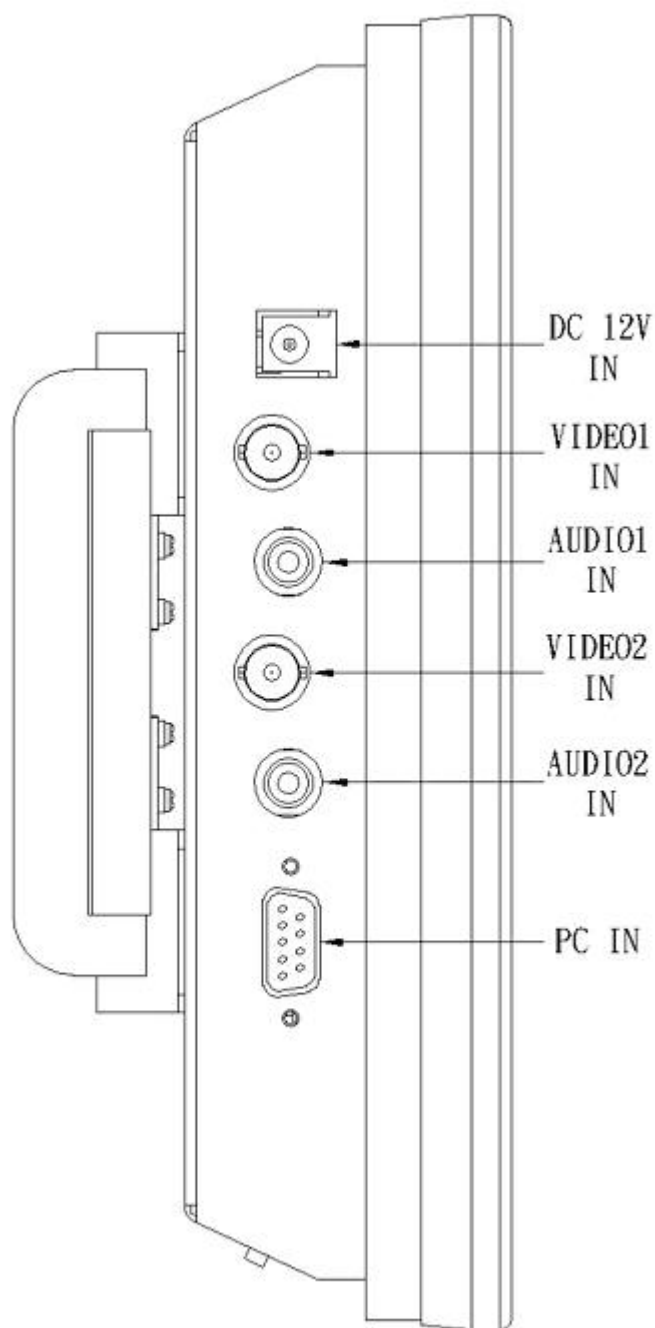

OSD Architecture

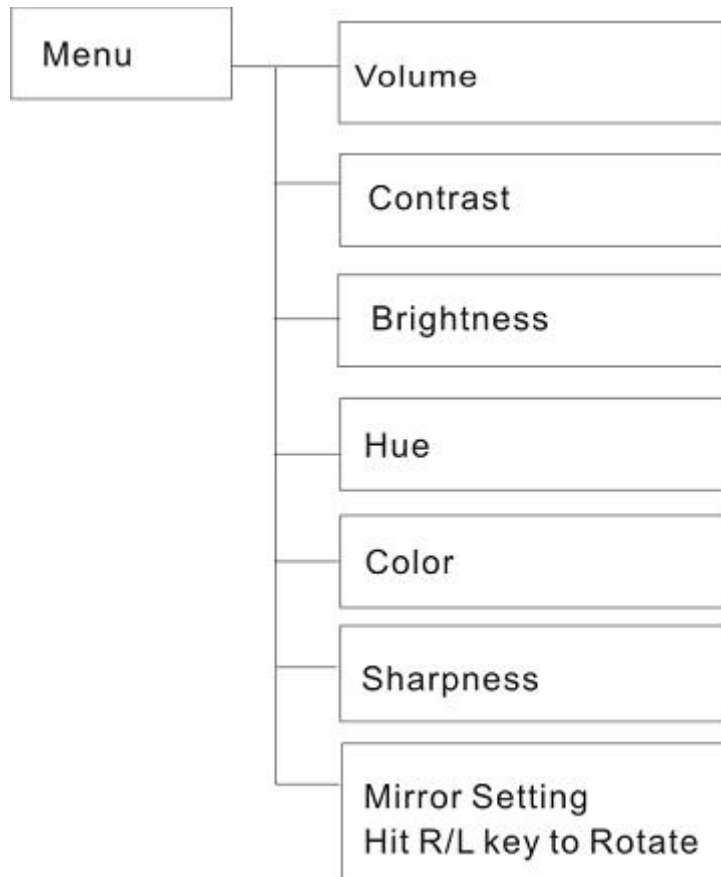

Under AV1, AV2 mode:

Press the MENU button bring up the OSD menu.

Press UP/DOWN to increase or decrease value on the OSD menu.

Volume:

Control built-in speakers output volume.

Contrast :

Permits adjustment for contrast between light or dark areas of the picture.

Example:



Brightness :

Adjusts the overall picture shade and brightness.

Tip: Use the Brightness to make details in the dark areas of the picture to be just visible, and Contrast to “brighten” the picture without causing noises and foreheads to turn white.

Hue :

Adjust all the colors on the screen, but is most noticeable to the eye in reds and yellows, and is also usually set for pleasing face tones.

Color :

Adds coloring to the black and white picture content (of a color signal), and is usually set for viewer's preference in color saturation.

Sharpness :

Sets the desired sharpening enhancement to the picture.

Mirror Setting :

Hit R/L key to Rotate.

PC Mode Function:

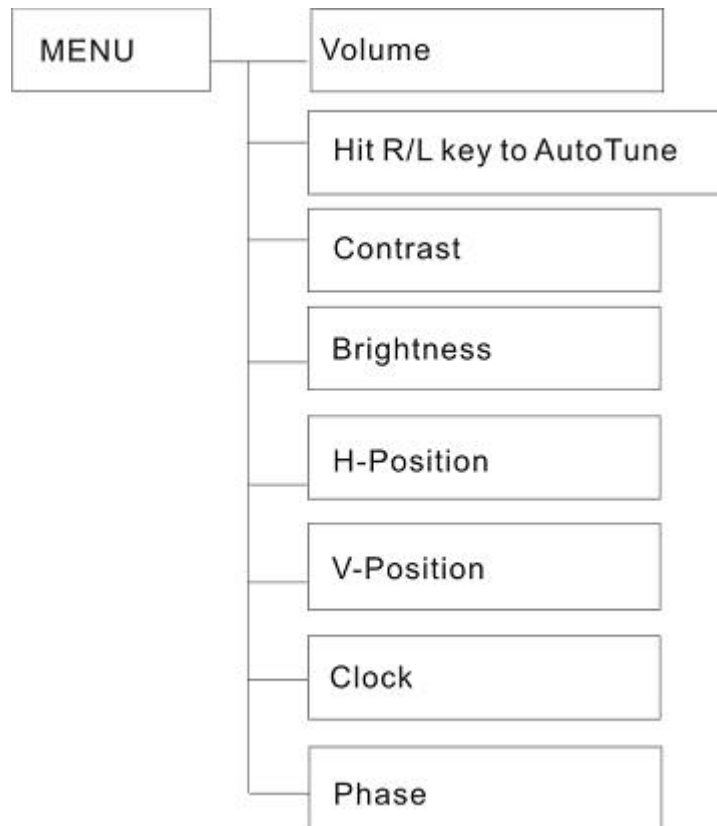

Under Image mode:

Press the MENU button bring up the OSD menu.

Press UP/DOWN to increase or decrease value on the OSD menu.

Hit R/L key to Auto Tune: Automatically selects the optimal settings for image parameters.

Contrast: Adjusts fore ground white level of the screen image.

Brightness: Adjusts background black level of the screen image.

H-Position: Controls the picture horizontal position.

V-Position: Controls the picture vertical position.

Clock: Adjust the internal pix clock lag in order to optimize the screen image.

Phase: Adjust the internal clock time lag in order to optimize the screen image.

LCD monitor Mounting Guide

Wall mount:

Free your space with wall mount design.

Please adjustment the screwed in side panel to install the LCD to the wall.

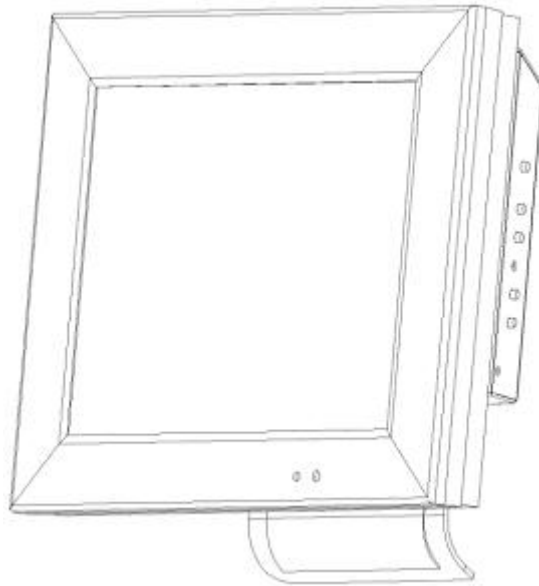

Connecting Device

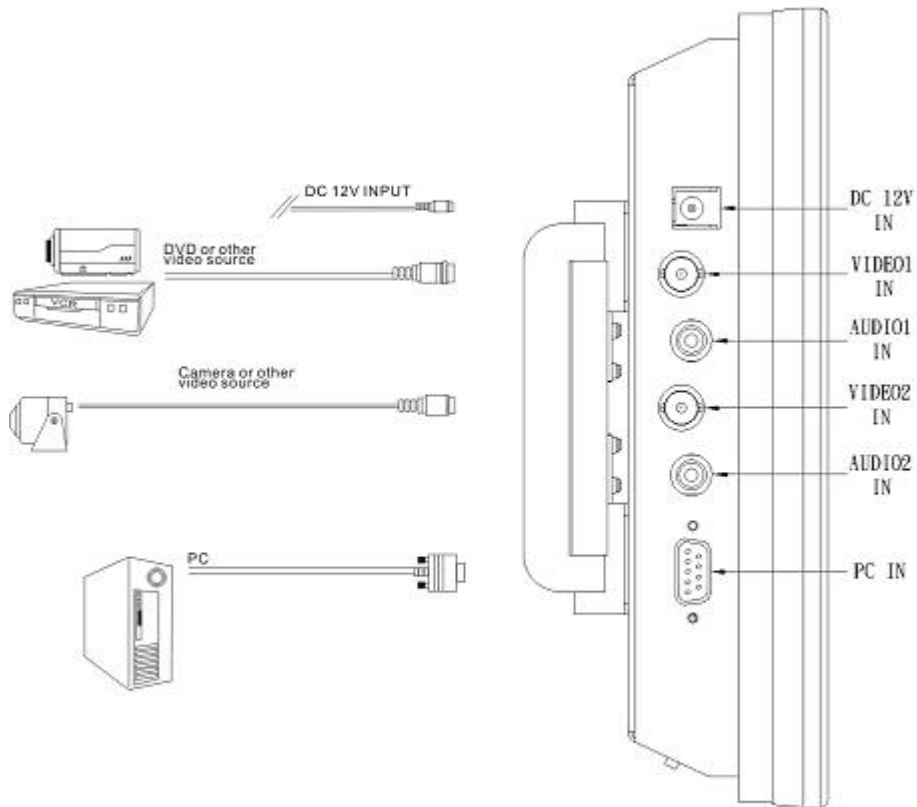

- Connect PC to Monitor through VGA connector as shown on the above picture
- Connect External device such as DVD or Game Player to Monitor as shown on the above picture
- Connect CCD Camera 1 and 2 to Monitor through Video Input 1 and 2 (BNC Connect) as showing on the above picture

e. Support Resolution:

640x480	60Hz
800x600	60Hz

Specification

Model	LCD80AVH	
LCD Panel	8.0" TFT LCD	
Display Colors	262K	
Display area	162X121.5mm	
Resolution	800X600 (SVGA)	
Brightness	500cd/m ²	
Contrast Ratio	400:1 typ.	
Response Time (Tr+tf)	12/18 ms (30 ms)	
View angle	L/R	140
	U/D	135
Video Input	1.0 Vp-p Composite: BNCx2 Input VGA-----D-Sub 15Pin Input	
Audio In/Out	RCA(IN)X2 2W/8ohm(mono)	
Operating	Power ON/OFF OSD Control Function	
Power Supply	DC12V	
Power Consumption	800mA(9.6W)	
Weight	1.5kg	
Dimensions (with stand)	216.6 x 175.3 x 54mm with mount 231.4 x 227.6 x 45mm	
Environment	Operating: 0°C~50°C / Humidity: 10%~85% Storage: -20°C~70°C / Humidity: 10%~85%	

Appendixes

A. TROUBLE SHOOTING

Problem:

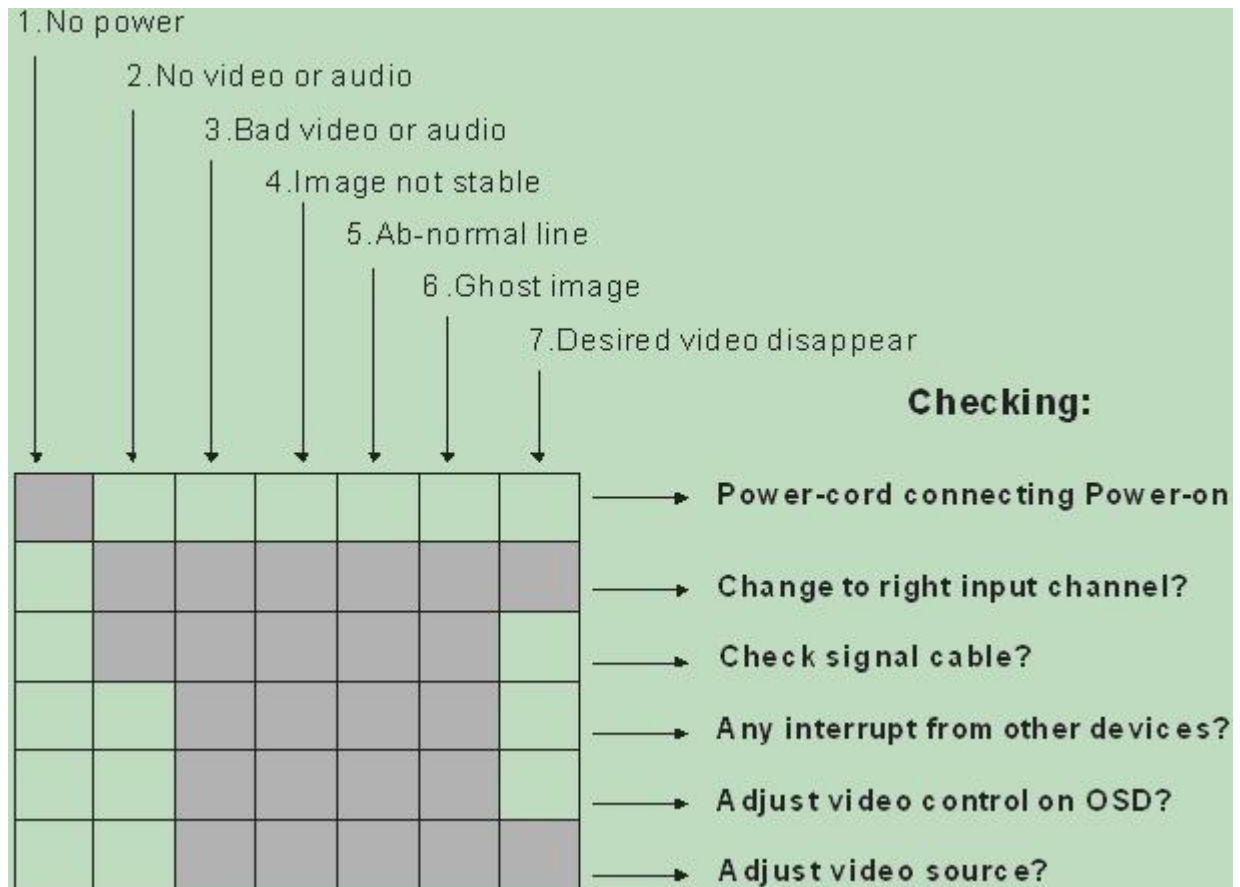

Package List

- A. LCD Monitor x 1
- B. User Manual x 1
- C. Remote Control x 1
- D. AC adaptor x 1
- E. Mains Lead x 1

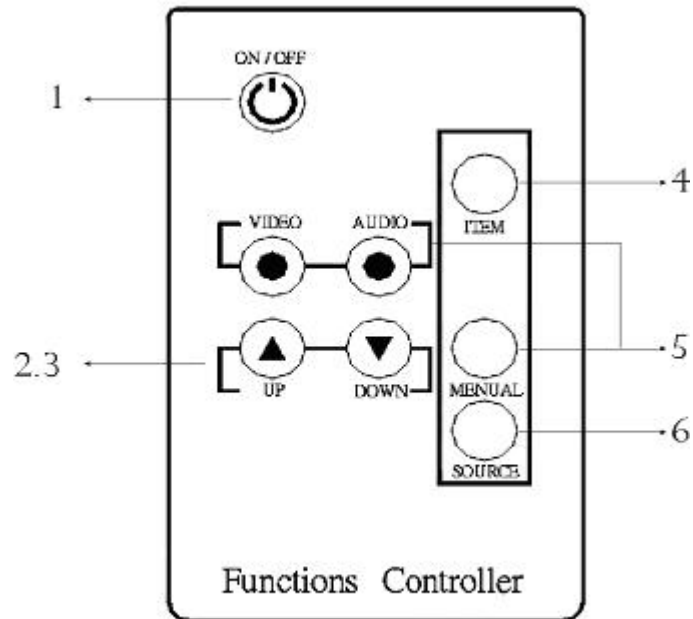



1. Power

Monitor power ON / OFF. At OFF mode, monitor will be at standby status.

LED-Green Light -- Power On

Red Light -- Standby mode

2. 3. Adjust  / 

Increase or decrease the value on OSD menu.

 Increase value on the OSD Menu.

 Decrease value on the OSD Menu.

4. NC

5. Menu

OSD Menu control.

6. Source

Select input signal from AV1, AV2, VGA.