

TFT LCD MONITOR

USER MANUAL

LCD190AV-DE

LCD190AV-1DE



CE

WARNING:

TO REDUCE THE RISK OF FIRE OR ELECTRIC SHOCK, DO NOT EXPOSE THIS PRODUCT TO RAIN OR MOISTURE.

DO NOT INSERT ANY METALLIC OBJECT THROUGH VENTILATION GRILLS.

CAUTION:



Explanation of Graphical Symbols



The lightning flash with arrowhead symbol, within an equilateral triangle, is intended to alert the user to the presence of un-insulated “dangerous voltage” within the product’s enclosure that may be of sufficient magnitude to constitute a risk of electric shock to persons.



The exclamation point within an equilateral triangle is intended to alert the user to the presence of important operating and maintenance (servicing) instructions in the literature accompanying the product.

Precautions

Safety-----

Should any liquid or solid object fall into the cabinet, unplug the unit and have it checked by the qualified personnel before operating it any further.

Unplug the unit from the wall outlet if it is not going to be used for several days or more. To disconnect the cord, pull it out by the plug. Never pull the cord itself.

Allow adequate air circulation to prevent internal heat built-up. Do not place the unit on surfaces(rugs, blankets, etc.) or near materials (curtains, draperies) that may block the ventilation holes.

Installation-----

Do not install the unit in an extremely hot or humid place or in a place subject to excessive dust or mechanical vibration.

The unit is not designed to be waterproof. Exposure to rain or water may damage the unit.

Cleaning-----

Clean the unit with a slightly damp soft cloth. Use a mild household detergent. Never use strong solvents such as thinner or benzene as they might damage the finish of the unit.

Retain the original carton and packing materials for safe transport of this unit in the future.

Federal Communications Commission (FCC) Statement

This Equipment has been tested and found to comply with the limits for a Class B digital device, pursuant to Part 15 of the FCC rules. These limits are designed to provide reasonable protection against harmful interference in a residential installation. This equipment generates, uses and can radiate radio frequency energy and, if not installed and used in accordance with the instructions, may cause harmful interference to radio communications.

However, there is no guarantee that interference will not occur in a particular installation.

If this equipment does cause harmful interference to radio or television reception, which can be determined by turning the equipment off and on, the user is encouraged to try to correct the interference by one or more of the following measures:

- Reorient or relocate the receiving antenna.
 - Increase the separation between the equipment and receiver.
 - Connect the equipment into an outlet on a circuit different from that to which the receiver is connected.
 - Consult the dealer or an experienced radio/TV technician for help.
- You are cautioned that changes or modifications not expressly approved by that party responsible for compliance could void your authority to operate the equipment.

This device complies with Part 15 FCC Rules. Operation is subject to the following two conditions:

- (1) This device may not cause harmful interference.
- (2) This device must accept any interference received including interference that may cause undesired

Table Of Contents

● Warning.....	1
● Safety Precautions.....	2
● Table Of Contents.....	3
● Features.....	4
● Operating Instruction.....	5
● Connections.....	6
● OSD Architecture.....	7
A. OSD Function.....	7~8
B. OSD Function PC Mode	9
● LCD Monitor Mounting guide.....	10
● Connecting Device.....	11
● Specification.....	12
● Appendixes.....	13
● Remote Control.....	14

Features

LCD190AV-DE/1DE

- Compatible with VGA (640 x 480), SVGA (800 x 600).XGA(1024x768).SXGA(1280x1024)
- Support vertical refresh rate up to 75 Hz for VGA, SVGA.XGA.(SXGA 60HZ)
- Automatic or manual detection of separate synchronize and composite synchronize of VGA signal
- 19-inch LCD monitor with multiple inputs. (Composite video, Y/C and D-sub &DVI computer)
- High brightness of 300 cd/m² / 400 cd/m²
- With 3D comb filter
- High contrast 800:1.
- High quality Horizontal and Vertical Scaling with 3D De-interlacing for Display
- Wide viewing of 170°, vertical and 160° horizontal.
- Fast LCD response time of 5ms.
- Luminance transient improvement(LTI),Chrominance transient improvement(CTI)
- Video input support NTSC / PAL standard.
- Built-in high precision Y/C Input signal.
- Video out support auto termination (75 Ohms).
- Audio live-out function with stereo phone Jack output.
- Build-in 2W+2W speaker.
- Support IR remote controller.
- VESA standard (100mm x 100mm) bracket.
- Wall mountable capability.

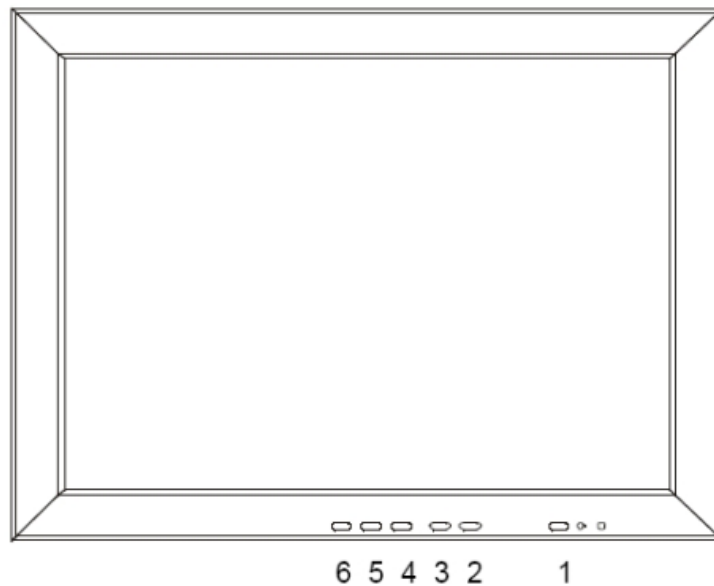

1. Power

Monitor power ON / OFF. At OFF mode, monitor will be at standby status.

LED-Green Light -- Power On

Red Light -- Standby mode

2. 3. Adjust /

Increase or decrease the value on OSD menu.

 Increase value on the OSD Menu.

 Decrease value on the OSD Menu.

4. Item (Option)

PIP / POP /function selection.

5. Menu

OSD menu selection.

6. Source

Select input signal from AV1, AV2, S-Video or VGA, DVI.

Connection

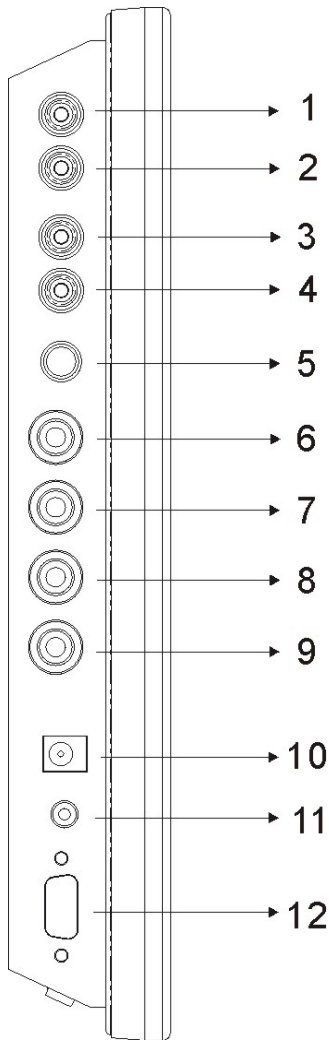

- 1 AUDIO 2 OUT**
Audio looping outputs for AUDIO 2
- 2 AUDIO 2 IN**
Audio Signal Input, this input is for AV2, PC or Y/C (refer to Note below)
- 3 AUDIO 1 OUT**
Audio looping outputs for AUDIO 1
- 4 AUDIO 1 IN**
Audio Signal Input, this input is for AV1
- 5 Y/C IN (S-Video)**
Y/C separated signal Input
- 6 VIDEO 2 OUT**
Video looping output for VIDEO 2
- 7 VIDEO 2 IN**
Composite signal Input for VIDEO 2
- 8 VIDEO 1 OUT**
Video looping output for VIDEO 1
- 9 VIDEO 1 IN**
Composite signal Input for VIDEO1
- 10 Regulated DC12V Power Input**
- 11 AUDIO LIVE OUT**
- 12 PC VGA IN**
- 13 DVI input (Optional) Not shown**

NOTE:

Connections of Audio

	Audio 1	Audio 2
PC		✓
AV1	✓	
AV2		✓
S-Video		✓

A. OSD Function

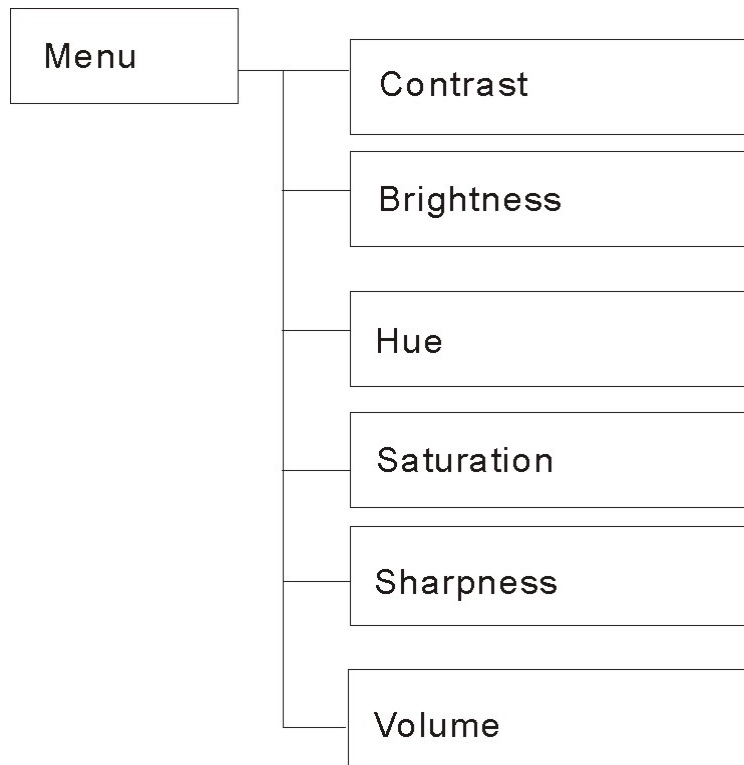

Under AV1, AV2, S-Video mode:

Press the MENU button to bring up the OSD Menu.

Press ◀ ▶ to select VIDEO. Then, press ITEM to choose functions that require proper adjustments.

As shown, press ◀ ▶ key to adjust.

Note: In remote control, press   **key to adjust.**
UP DOWN

(After adjustment, the monitor will store new settings)

Contrast

Permits adjustment for contrast between light or dark areas of the picture.

Example:

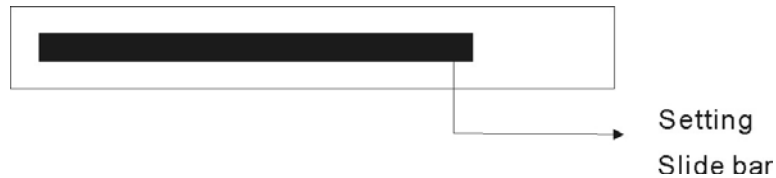

Brightness

Adjusts the overall picture shade and brightness.

Tip: Use the Brightness to make details in the dark areas of the picture to be just visible, and Contrast to “brighten” the picture without causing noises and foreheads to turn white.

Hue

Adjust all the colors on the screen, but is most noticeable to the eye in reds and yellows, and is also usually set for pleasing face tones.

Note: Appears in NTSC mode only.

Saturation

Adds coloring to the black and white picture content (of a colour signal), and is usually set for viewers preference in colour saturation.

Sharpness

Sets the desired sharpening enhancement to the picture.

Volume

Control built-in speakers' output Volumes

B. OSD Function (PC Mode Only)

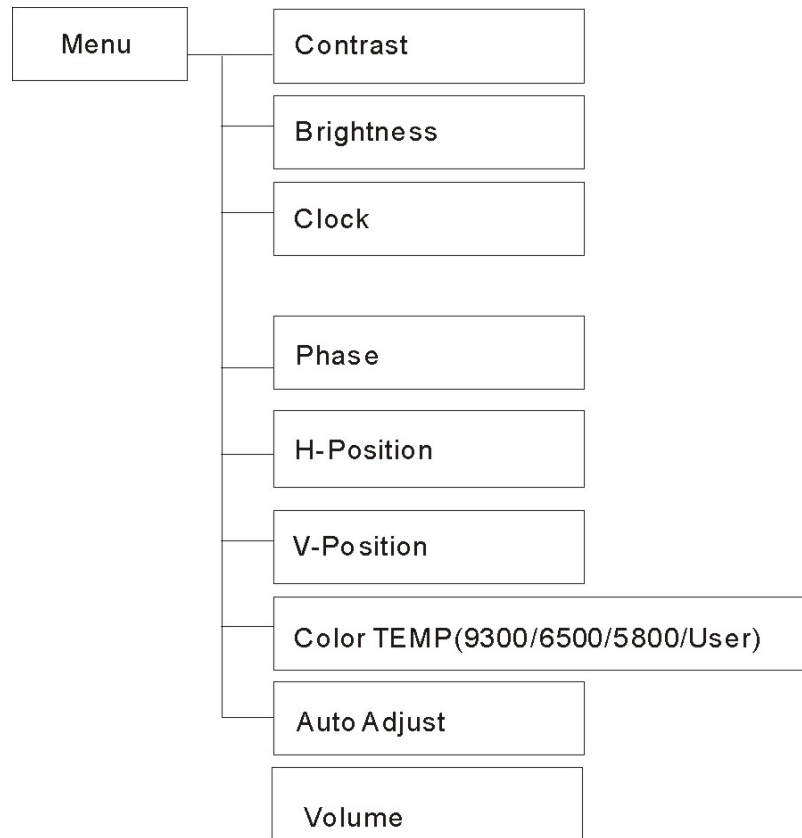

Under Image mode:

Press the MENU button to bring up the OSD Menu.

Press ◀ ▶ again to select IMAGE. Then, press ITEM to choose functions that require proper adjustments.

As shown, press ◀ ▶ key to adjust.

Note: In remote control, press   **key to adjust.**
UP DOWN

(After adjustment, the monitor will store new settings)

LCD monitor Mounting Guide

A. Desktop

Adjust the viewing angle of LCD to fit most comfortable monitoring status.

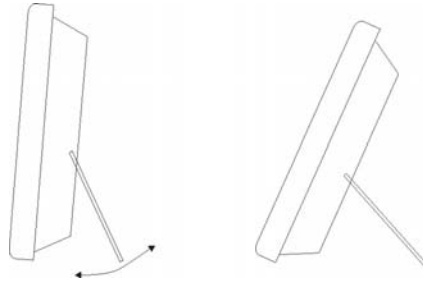

B. Wall mount

Free your space with wall mount design.

Please follow the fix-hole size in back panel to install the LCD to the wall.

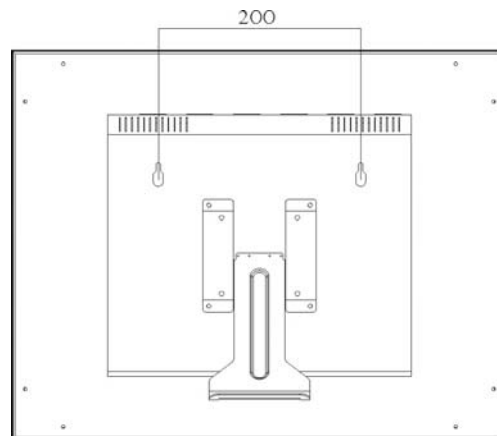

C. VESA Bracket

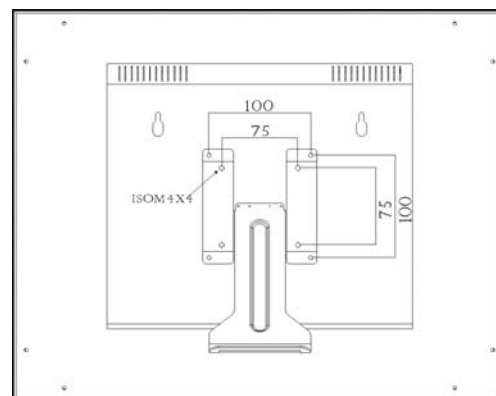

Connecting Device

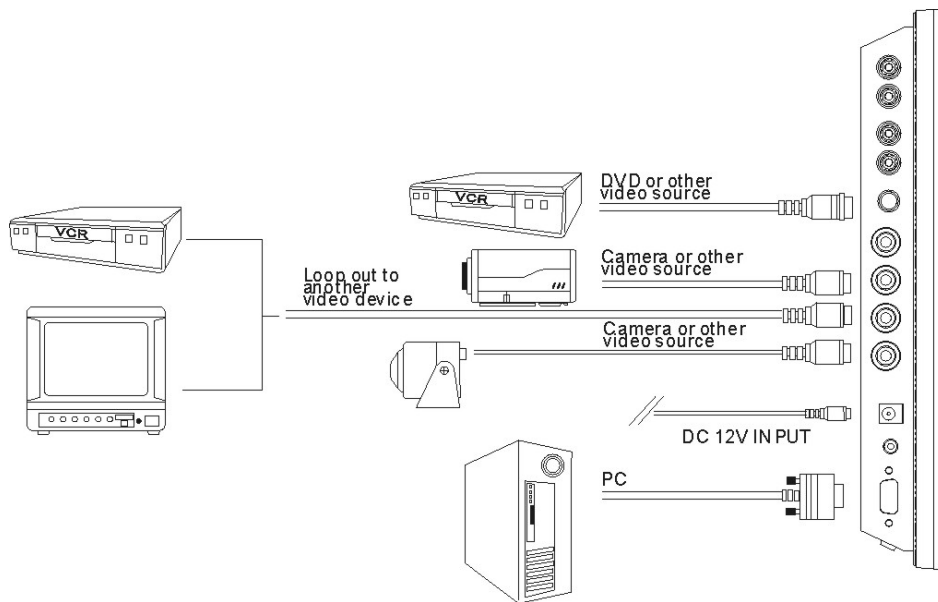

- Connect PC to Monitor through VGA connector as shown on the above picture.
- Connect External device such as DVD or Game Player to Monitor as shown on the above picture.
- Connect CCD Camera 1 and 2 to Monitor through Video Input 1 and 2 (BNC Connect) as showing on the above picture.
- Support Resolution

LCD190AV-DE/1DE

640 x 480	60Hz	800 x 600	56Hz	1024 x 768	60Hz
640 x 480	72Hz	800 x 600	70Hz	1024 x 768	70Hz
640 x 480	75Hz	800 x 600	72Hz	1024 x 768	75Hz
		800 x 600	75Hz	1280 x 1024	60Hz

Appendixes

A. TROUBLE SHOOTING

Problem:

1.No power

2.No video or audio

3.Bad video or audio

4.Image not stable

5.Ab-normal line

6.Ghost image

7.Desired video disappear

Checking:

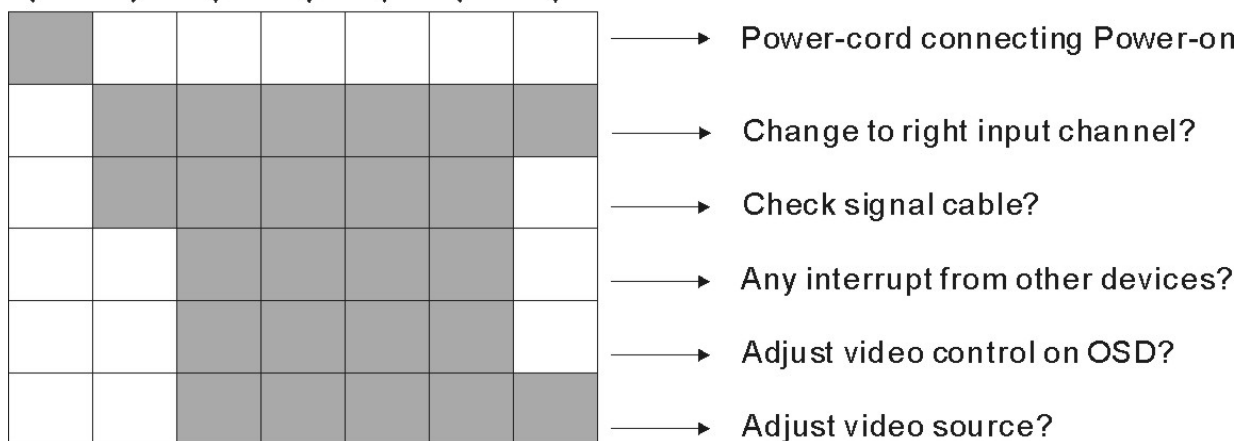

Package List

- A. LCD Monitor x 1
- B. Power Cord x 1
- C. Accessory Kit
 - a. DB15-DB15 VGA Cable x1 x 1 optional
 - b. 1/8" male to 1/8@ male audio cable x 1 optional
- D. User Manual x 1
- E. 12V AC Power Adapter x 1
- F. Remote Control x 1

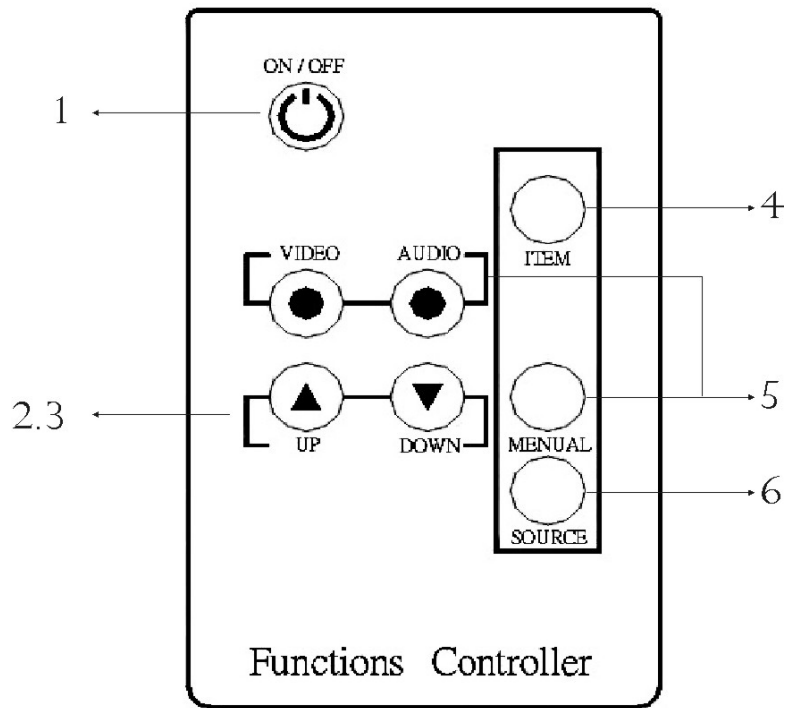

1. Power

Monitor power ON / OFF. At OFF mode, monitor will be at standby status.

LED-Green Light -- Power On
Red Light -- Standby mode

2. 3. Adjust  / 

Increase or decrease the value on OSD menu.

 Increase value on the OSD Menu.

 Decrease value on the OSD Menu.

4. Item (Option)

PIP/POP selection.

5. Menu

OSD menu control.

6. Source

Select input signal from AV1, AV2, S-Video or PC.